

FY | Series
Controller

FY400 FY700
FY600 FY800
FY900

New-Generation FY Series
Digital PID Temperature Controller



TAIE

TAIWAN INSTRUMENT & CONTROL CO., LTD

Classical Re-evolution

High Performance
With Best Process Control

High Quality

Precise Control

High Reliability

High Accuracy $\pm 0.1\%$

Sampling Time 50ms



Speed upper to
115200 bps

Excellent Anti-Interference Ability

Adopt new anti-interference algorithm and pass the highest level of EMC verification in CE certification. It can resist electromagnetic interference in heavy noise environment.



IP65 Proof

IP65 dust & water proof is available for all models (optional function).



High Speed Sampling and High Accuracy

Both loops can perform high-speed sampling for 50ms, enabling stable control and response. Built-in 18-bit high resolution ADC circuit provides up to 0.1% accuracy.



Certification and Universal Voltage

All models get CE approval. operate on any voltage from AC 85~265V at 50/60 Hz, DC 24V is also available.



Customize Function Key

It can be quickly executed the event by A/M key.
Ex: auto/manual switch, run/stop switch etc.



Autotuning(AT)

AT Function can calculate the optimize PID value for your control system, without trying.

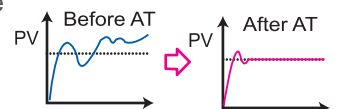

Status Indicator Light

Real time monitor the status of output(OUT1/OUT2) , alarm(AL1/AL2/AL3), auto-tuning(AT), manual output(MAN) and program execute(PRO).



Bar-Graph

The output percentage is directly displayed on the panel with a bar-graph indicator 10 LED's corresponding to every 10% differential in output (0~100%) (except FY400).



Function block diagram

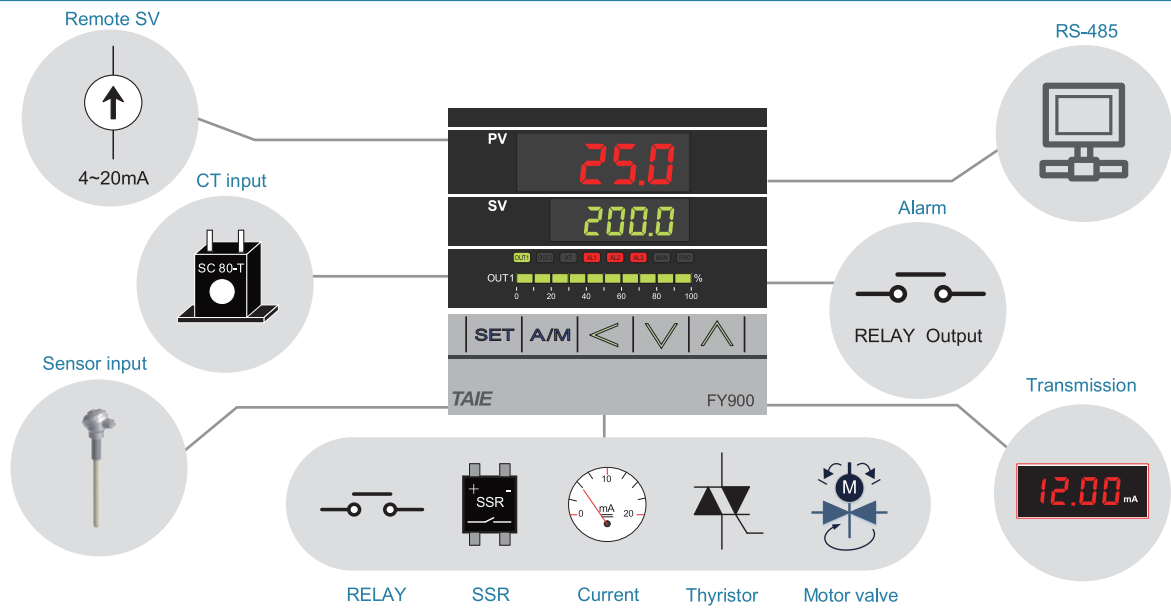

Features

Various I/O Types

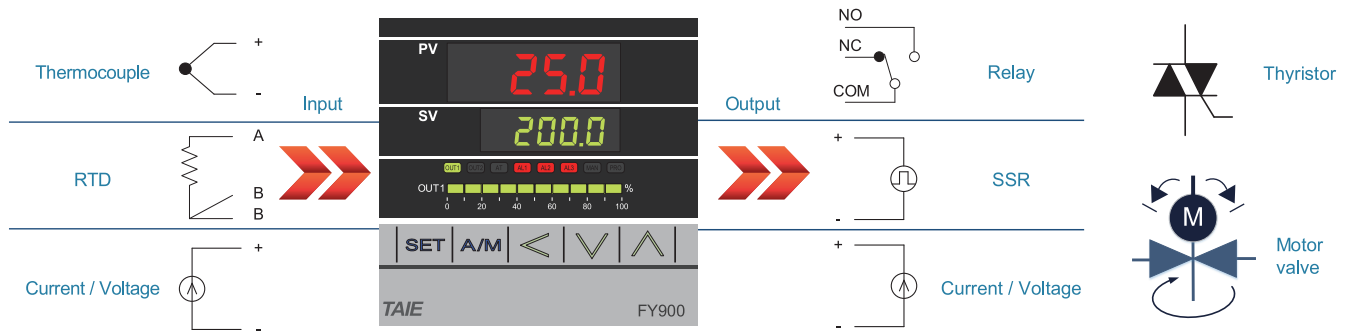

Excellent Control Performance

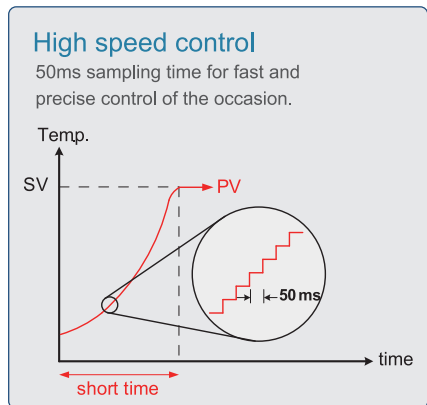
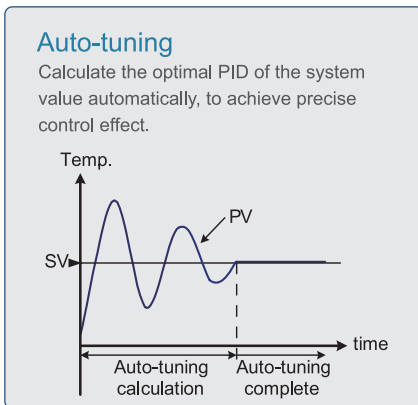
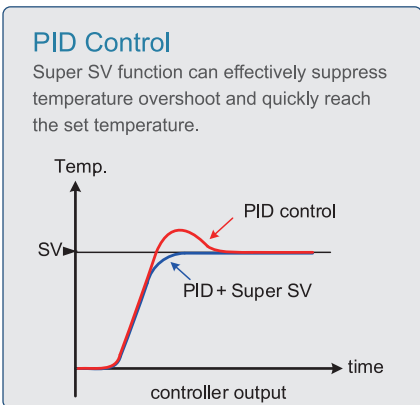

Powerful Program Control

Provides 18 patterns of 18 segments of program control, each segment can be arbitrarily set to ramp, soak, step or cool down temperature, the user can be arbitrary according to the demand, the maximum can support to 144 segments program control.

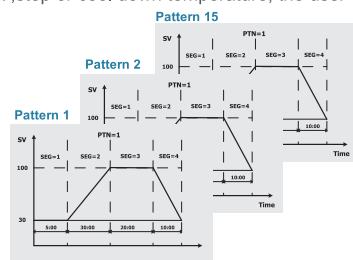
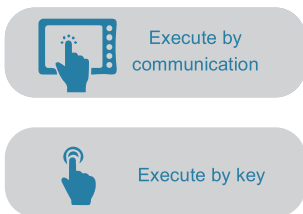

Features

Heating and Cooling Control

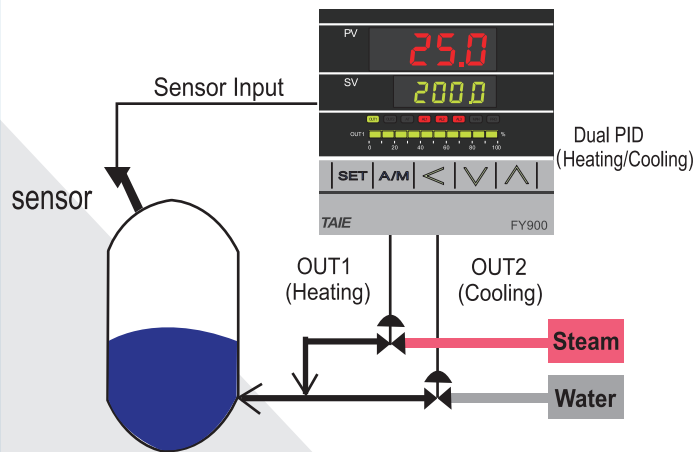

Motor Valve Control

Can use position feedback control of valve opening input or servo control without valve opening input.

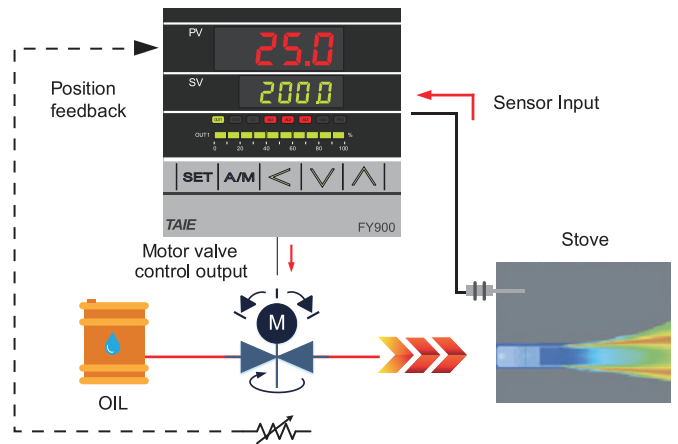

Transmission

Transfer parameter digital values as analog signals to external devices.
 signals : 0~20mA , 4~20mA , 0~5V , 1~5V , 0~10V ...
 parameters : SV1, PV1, MV1...

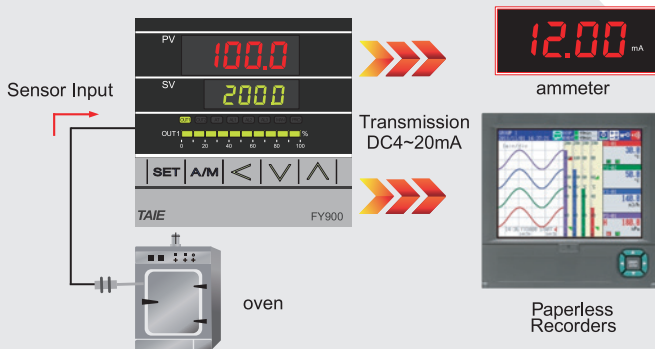

Remote SV

SV value is controlled by an analog signal from an external device.
 signals : 0~20mA , 4~20mA , 0~5V , 1~5V , 0~10V ...
 parameters : SV

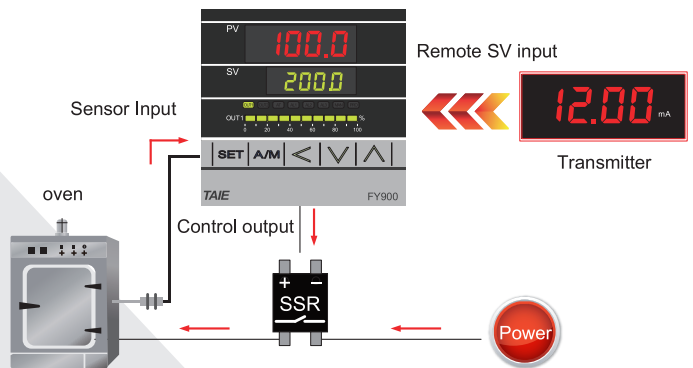

Communication

Compatible with Modbus RTU communication protocol to quickly establish links with HMI, PLC or SCADA software.

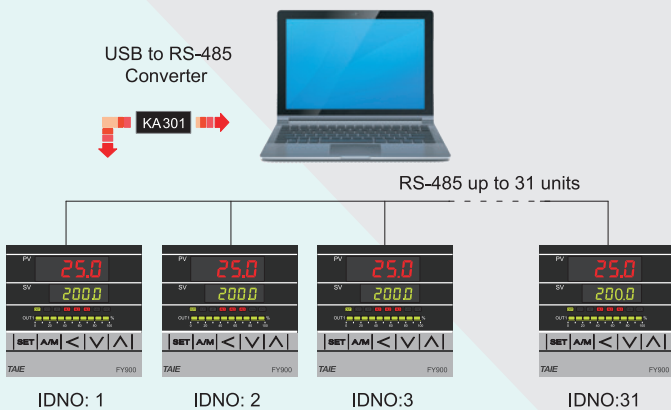

Heater Break Alarm(HBA)

With a CT (current transformer) to monitor the heater current in real time, when the current value is abnormally reduced an alarm signal can be output to notify the user.

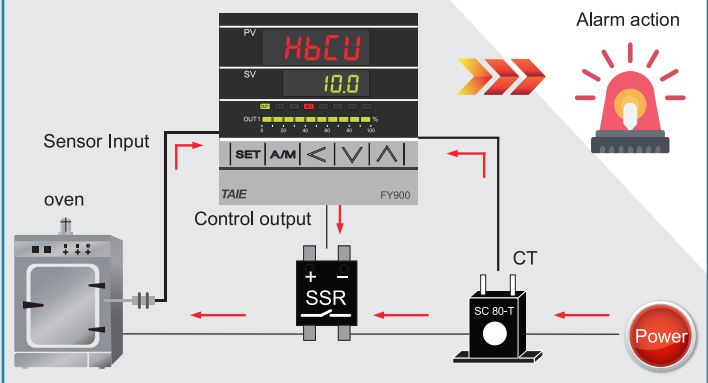

Appearance

Parts Description

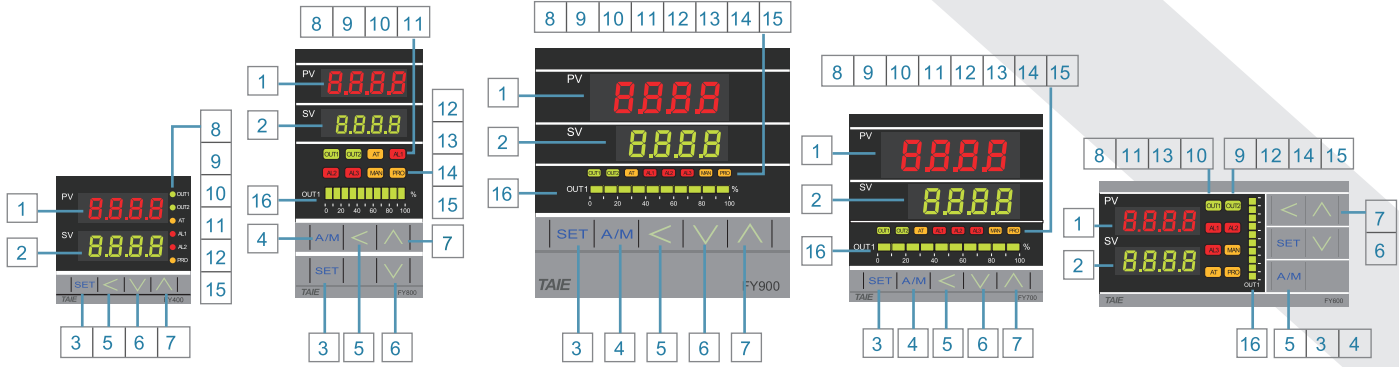

NO.	NAME	Function	NO.	NAME	Function
1	PV	Indicates PV (measured value) and character information such as parameter codes and error codes (Red)	9	OUT2	Lamp lit when OUT2 is activated (Green)
2	SV	Indicates SV (target set value) and parameter Values (Green)	10	AT	Lamp lit when Auto-tuning is activated (Orange)
3	SET	Used for parameter calling up and set value registration	11	AL1	Lamp lit when Alarm 1 is activated (Red)
4	A/M	Auto/manual switch or others function start	12	AL2	Lamp lit when Alarm 2 is activated (Red)
5	<	Shift digits when settings are changed	13	AL3	Lamp lit when Alarm 3 is activated (Red)
6	∨	Decrease Key (-1000,-100,-10,-1)	14	MAN	Lamp lit when controller in manual mode or get error condition (Orange)
7	∧	Increase Key (+1000,+100,+10,+1)	15	PRO	Lights when program running (Orange)
8	OUT1	Lamp lit when OUT1 is activated (Green)	16	OUT%	Output percentage (Green)

External and Panel Cutout Dimensions

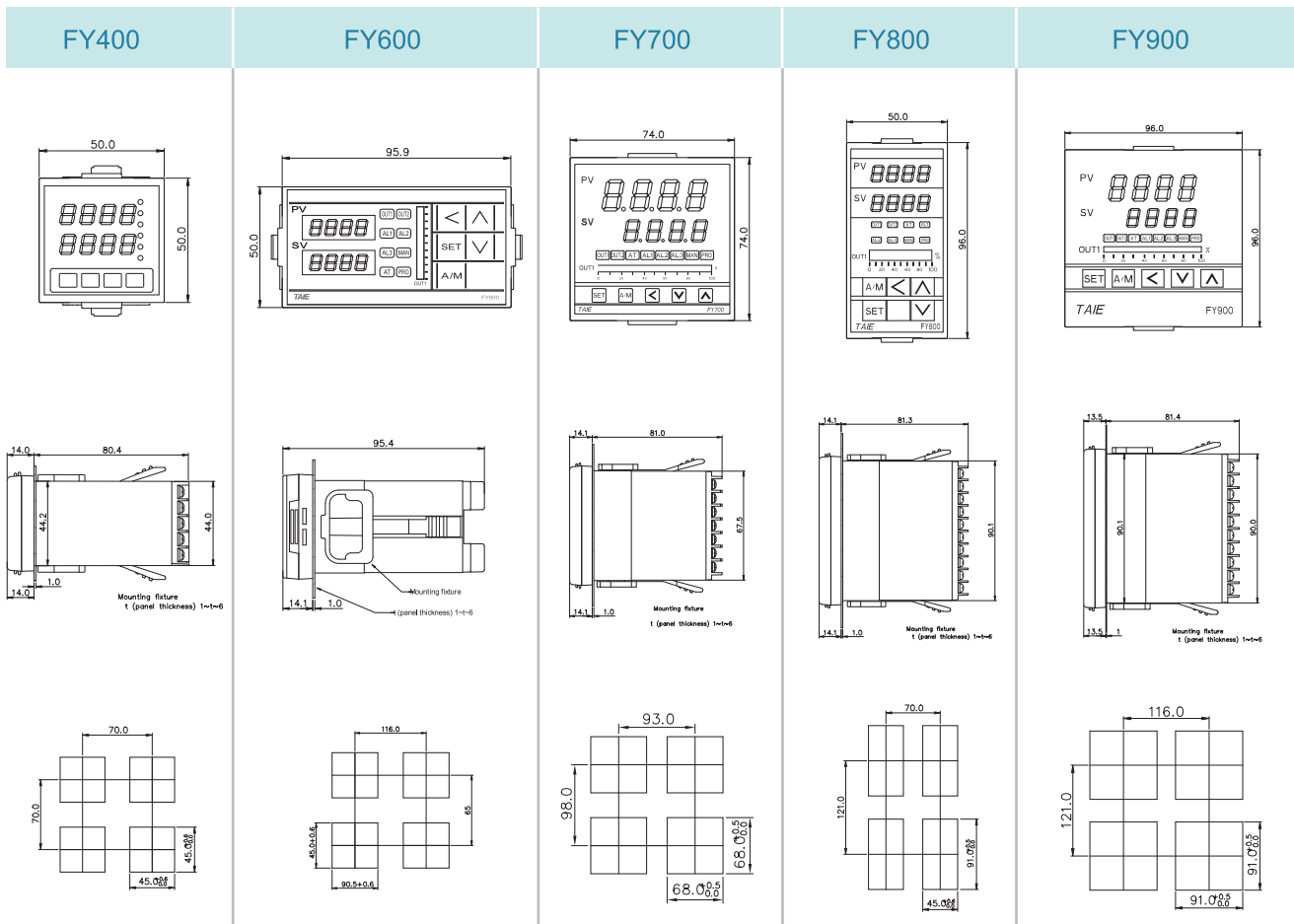

Terminal Arrangement

FY400

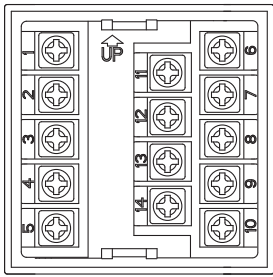

Power		Communication		Remote/CT Input	
Output-1		1 Φ Zero cross		TRS	
Output-2					
Alarm-1 Alarm-2		Motor valve		Input	

FY700

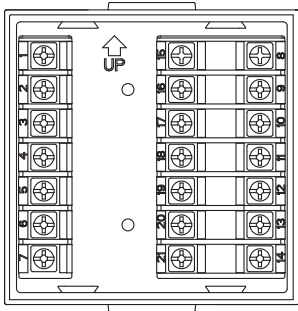

Power		Alarm-1 Alarm-2 Alarm-3		CT Input	
Output-1		Communication		1 Φ Zero cross Phase angle	
Output-2		TRS			
Motor valve		Remote		Input	

FY600/800

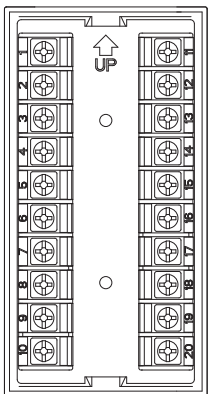

Power		Motor valve		TRS	
Output-1		Alarm-1 Alarm-2 Alarm-3		Remote/CT Input	
Output-2		Communication		Input-1	

FY900

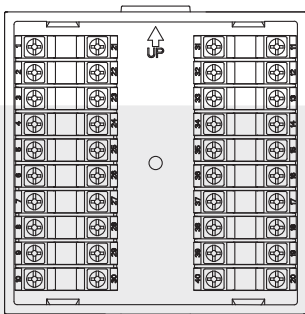

Power		Alarm-1 Alarm-2 Alarm-3		Input-1	
Output-1		Communication		1 Φ / 3 Φ Zero cross	
Output-2		TRS			
Motor valve		Remote/CT Input		1 Φ Phase angle	

Specifications

Standard Spec.	
Supply voltage	AC 85 ~ 265V, DC 24V DC24V DC $\pm 10\%$
Power Consumption	AC approx. 6VA / 240V AC DC approx. 4W
Memory	Non-volatile memory Maximum writes : 1,000,000 times Data retention : 10 years
Operating temperature	0 ~ 50°C (32 ~ 122)°F
Humidity range	20% ~ 90% RH
Weight	FY400 approx. 120g FY600 approx. 170g FY700 approx. 150g FY800 approx. 170g FY900 approx. 230g
Dimension (mm)	FY400 48W X 48H X 95.5L (1/16 DIN) FY600 96W X 48H X 95.5L (1/8 DIN) FY700 72W X 72H X 95.5L (3/16 DIN) FY800 48W X 96H X 95.5L (1/8 DIN) FY900 96W X 96H X 95.5L (1/4 DIN)
Operating environment	Non-corrosive, flammable gas, slight dust ring environment, no high frequency, no direct shock, places the sun is not directly exposed.
Input	
Accuracy	Cold junction compensation diode external $\pm(0.1\%$ of reading+1 digit) Cold junction compensation diode inside $\pm(0.3\%$ of reading+1 digit)
Sampling time	50ms
TC	K ` J ` R ` S ` B ` E ` N ` T ` W ` PLII ` L
RTD	PT100
mA dc	0~5V ` 0~10V ` 0~2V ` 1~5V ` 2~10V ` 0~25mV ` 0~50mV ` 0~20mA ` 4~20mA ` 0~1V ` 10~50mV ` 0~70mV
Input filter	First-order low-pass filter Time constant : 0.1 to 10.0 sec. (when set to 0, the filter is off)
Output	
Set	Maximum 2 sets
Control	1. PID, P, PI, and PD control (including AT function) 2. ON/OFF control 3. Heat and Cooling PID control (including AT function)
Relay	1. SPST-NO, 250VAC, 5A Electrical life:100,000 times 2. SPDT-NO, 250VAC, 5A Electrical life: 50,000 times 3. SPDT-NC, 250VAC, 2A Electrical life: 20,000 times
SSR	ON: 24V OFF 0V Maximum load current : 20mA With short circuit protection circuit
mA	Resolution : 10 bits Signal type : 4~20mA ` 0~20mA ` 0~5V ` 0~10V ` 1~5V ` 2~10V

Heater Break Alarm(HBA)	
CT model	SC 80-T ` SC 100T
Maximum current	SC 80-T : 80A ` SC 100-T : 100A
Accruacy	SC80-T: $\pm 3\%$ ` SC100-T: $\pm 5\%$
Aperture	SC 80-T : 5.9mm ` SC 100-T : 12.6mm
Output	Free load alarm 1~3
Alarm	
set	Maximum 3 sets
Mode	Program end ` System error ` HBA ` Soak timer ` Deviation high ` Deviation low ` Process high ` Process low ` Program run ` System normal ` Ramp Soak Timer ` Counter
Relay specifications (resistive load)	1. SPST-NO, 250VAC, 5A Electrical time : 100,000 times 2. SPDT-NO, 250VAC, 5A Electrical time : 50,000 times 3. SPDT-NC, 250VAC, 2A Electrical time : 20,000 times
Transmission	
set	1 set
Resolution	14 bits
Accuracy	0.1%
Parameters	PV ` SV
Signal Type	4~20mA ` 0~20mA ` 0~5V ` 0~10V ` 1~5V ` 2~10V
Remote	
set	1 set
Resolution	18 bits
Parameters	Local SV
Signal Type	4~20mA ` 0~20mA ` 0~5V ` 0~10V ` 1~5V ` 2~10V
Motor Valve	
set	1 set
Resolution	18 bits
Parameters	PV2
Signal Type	1K Ω ` 560 Ω
Communication	
Communication	RS-485
Protocol	Modbus RTU ` TAIE
Baud rate	2400 ` 4800 ` 9600 ` 19200 ` 38400 ` 57600 ` 115200 bps
Communication format configuration	1. Starting bit : 1 2. Information bits : 8 3. Bit check : None ` Odd ` Even 4. Stop bits : 1 or 2
Reponses time	0~250ms
Maximum connections	31pcs

Order Information

Block means optional functions with additional charge

Model	Output 1	Output 2	Alarm	TRS	Remote	COMM	Input type	Power	Accessories
FY900(Red/Green light) FY901(Blue/White light) PFY900(Program)	1 0	1 0	1 0	0 0	0 0	0 3 B	0 1 A D	A AC 85-265V D DC 24V	N T W R
FY400 48x48mm FY600 96x48mm FY700 72x72mm FY800 48x96mm FY900 96x96mm	0 None 1 Relay 2 Voltage Pulse (SSR Drive) 3 4-20mA 4 0-20mA A 0-5V B 0-10V C 1-5V D 2-10V	0 None 1 Relay 2 Voltage Pulse (SSR Drive) 3 4-20mA 4 0-20mA A 0-5V B 0-10V C 1-5V D 2-10V	0 None 1 1Set 2 2Sets 3 3Sets A HBA B HBA+AL2 C HBA+AL2+AL3	0 None 1 4-20mA 2 0-20mA A 0-5V B 0-10V C 1-5V D 2-10V	0 None 1 4-20mA 2 0-20mA A 0-5V B 0-10V C 1-5V D 2-10V M Motor valve control feedback	0 None 3 TTL B RS-485	See input type table code	A AC 85-265V D DC 24V	N None T Terminal Cover IP65 W Terminal Cover +IP65 R Terminal Cover +IP65
PFY400 / 401 48x48mm PFY600 96x48mm PFY700 / 701 72x72mm PFY800 / 801 48x96mm PFY900 / 901 96x96mm	5 1 st SCR zero cross control 6 3 rd SCR zero cross control 7 Motor valve control 8 1 st SCR phase angle control	5 1 st SCR zero cross control 6 3 rd SCR zero cross control 7 Motor valve control 8 1 st SCR phase angle control							

※ HBA :Heater Break Alarm (HBA must use AL 1 as alarm relay)

Input Type Table

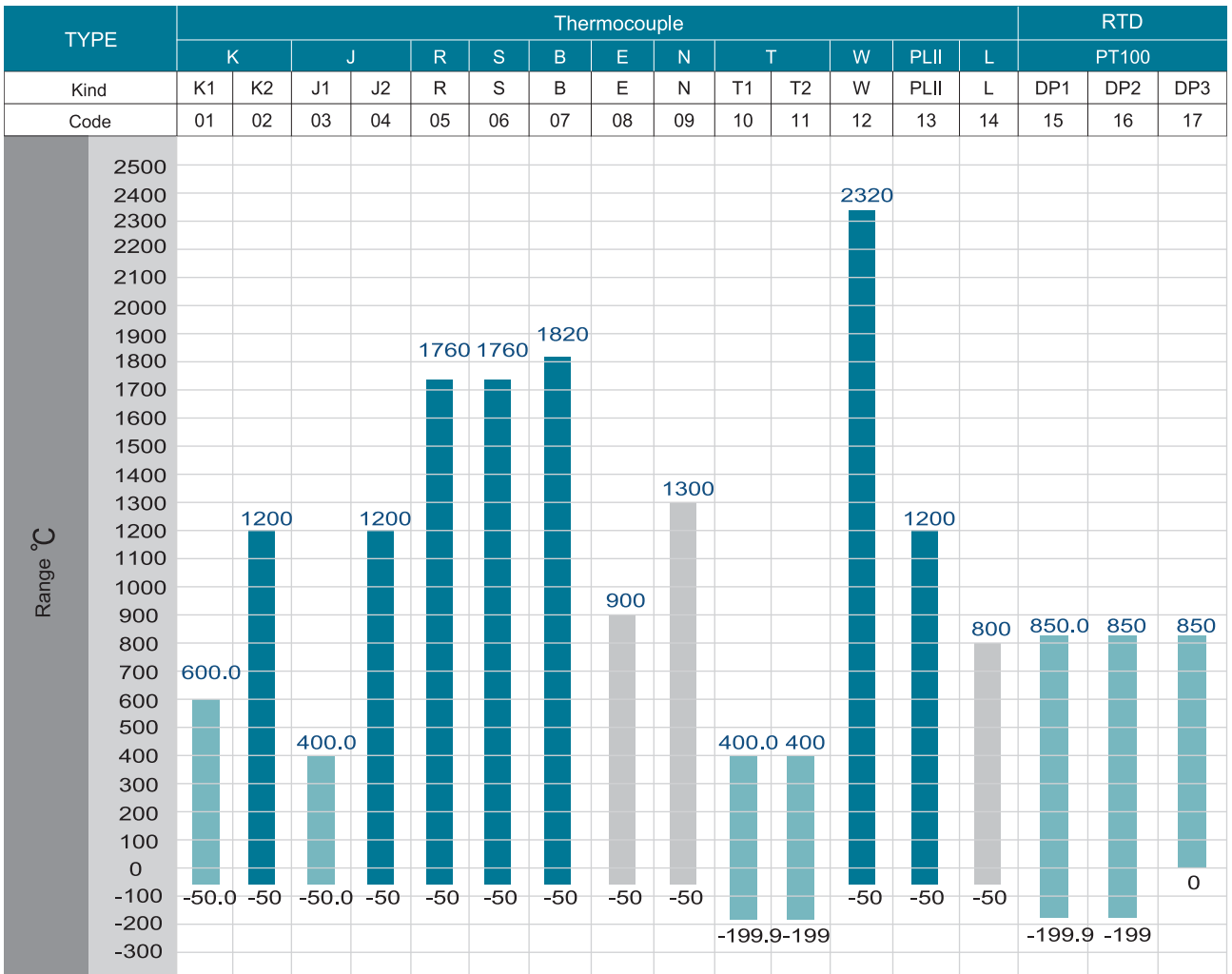

TYPE	LINEAR											
	AN1	AN2				AN3	AN4					
Code	18	19	20	21	22	23	24	25	26	27	28	29
Range	0~25mV	0~50mV	0~20mA	0~1V	0~2V	0~5V	0~10V	0~70mV	4~20mA	10~50mV	1~5V	2~10V

4 kinds of choices : -1999~9999 -199.9~999.9 -19.99~99.99 -1.999~9.999



Before operating this product, read the instruction manual carefully to avoid incorrect operation.
 This product is intended for use with industrial machines, test and measuring equipment.
 It is not design for use with medical equipment.
 If it is possible that an accident may occur as a result of the failure of the product or some other abnormality, an appropriate independent protection device must be installed.



TAIWAN INSTRUMENT & CONTROL CO., LTD
 COPYRIGHT © 2018 All Rights Reserved
 Printed in Taiwan

